

## DS-2DF8836IX-AEL(W) 8MP 36× Network IR Speed Dome



Hikvision DS-2DF8836IX-AEL(W) 8MP 36× Network IR Speed Dome adopts 2/3" progressive scan CMOS chip. With the 36× optical zoom lens, the camera offers more details over expansive areas.

This series of cameras can be widely used for wide ranges of high-definition, such as the rivers, forests, roads, railways, airports, ports, squares, parks, scenic spots, stations and large venues, etc.

### Key Features

- 2/3" progressive scan CMOS
- Up to 4096 × 2160 resolution
- Min. Illumination:  
Color: 0.005 Lux @(F1.5, AGC ON)  
B/W: 0.0005 Lux @(F1.5, AGC ON)  
0 Lux with IR
- 36× optical zoom, 16× digital zoom
- Digital WDR, 3D DNR, HLC, Smart IR
- 24 VAC & Hi-PoE
- Up to 200 m IR distance
- Support H.265+/H.265 video compression
- Deep-learning-based target classification algorithm for auto-tracking 2.0 and perimeter protection



## Specification

Camera Module	
Image Sensor	2/3" progressive scan CMOS
Min. Illumination	Color: 0.005 Lux @(F1.5, AGC ON) B/W: 0.0005 Lux @(F1.5, AGC ON) 0 Lux with IR
Shutter Time	1/1 s to 1/30,000 s
White Balance	Auto/Manual/ATW (Auto-tracking White Balance)/Indoor/Outdoor/Fluorescent Lamp/Sodium Lamp
AGC	Auto/Manual
Day & Night	IR cut filter
Digital Zoom	16×
Privacy Mask	24 programmable polygon privacy masks
Focus Mode	Auto/Semi-automatic/Manual
3D DNR	Support
BLC	Support
HLC	Support
Digital WDR	Support
Optical Defog	Support
EIS	Support
Regional Exposure	Support
Regional Focus	Support
Lens	
Focal Length	7.5 mm to 270 mm, 36× Optical
Zoom Speed	Approx. 7.8 s (optical lens, wide-tele)
Field of View	Horizontal field of view: 56.1° to 2.0° (wide-tele) Vertical field of view: 33.4° to 1.1° (wide-tele) Diagonal field of view: 62.9° to 2.3° (wide-tele)
Working Distance	10 mm to 1500 mm (wide-tele)
Aperture Range	F1.5 to F4.5
PTZ	
Movement Range (Pan)	360° endless
Pan Speed	Configurable, from 0.1°/s to 210°/s, Preset Speed: 280°/s
Movement Range (Tilt)	From -20° to 90° (Auto-flip)
Tilt Speed	Configurable, from 0.1°/s to 150°/s, Preset Speed: 250°/s
Proportional Zoom	Support
Presets	300
Patrol Scan	8 patrols, up to 32 presets for each patrol
Pattern Scan	4 pattern scans, record time over 10 minutes for each scan
Power-off Memory:	Support
Park Action	Preset/Pattern Scan/Patrol Scan/Auto Scan/Tilt Scan/Random Scan/Frame Scan/Panorama Scan
PTZ Status Display	Support
Preset Freezing	Support
Scheduled Task	Preset/Pattern Scan/Patrol Scan/Auto Scan/Tilt Scan/Random Scan/Frame Scan/Panorama Scan/Dome Reboot/Dome Adjust/Aux Output
Smart Features	
Perimeter Protection	Intrusion, Line Crossing, Region Entrance, Region Exiting Support alarm triggering by specified target types (human and vehicle) Filtering out mistaken alarm caused by target types such as leaf, light, animal, and flag, etc.
Event Detection	Face Detection, Audio Exception Detection

Smart Tracking	Manual Tracking, Auto Tracking (support tracking specified target types such as human and vehicle), Event Tracking
Smart Record	ANR (Automatic Network Replenishment), Dual-VCA
ROI	Support
<b>IR</b>	
IR Distance	200 m
Smart IR	Support
<b>Network</b>	
Max. Resolution	4096 × 2160
Main Stream	50Hz: 25fps (4096 × 2160, 3840 × 2160, 3072 × 1728, 2560 × 1440, 2048 × 1536, 1920 × 1080, 1280 × 960, 1280 × 720) 60Hz: 30fps (4096 × 2160, 3840 × 2160, 3072 × 1728, 2560 × 1440, 2048 × 1536, 1920 × 1080, 1280 × 960, 1280 × 720)
Sub-Stream	50Hz: 25fps (704 × 576, 640 × 480, 352 × 288) 60Hz: 30fps (704 × 480, 640 × 480, 352 × 240)
Third Stream	50Hz: 25fps (1920 × 1080, 1280 × 960, 1280 × 720, 704 × 576, 640 × 480, 352 × 288) 60Hz: 30fps (1920 × 1080, 1280 × 960, 1280 × 720, 704 × 480, 640 × 480, 352 × 240)
ROI	Support
SVC	Support
Video Compression	Main Stream: H.265+/H.265/H.264+/H.264 Sub-Stream: H.265/H.264/MJPEG Third Stream: H.265/H.264/MJPEG H.264 with Baseline/Main/High Profile
Audio compression	G.711alaw/G.711ulaw/G.722.1/G.726/MP2L2/PCM
Protocols	IPv4/IPv6, HTTP, HTTPS, 802.1x, Qos, FTP, SMTP, UPnP, SNMP, DNS, DDNS, NTP, RTSP, RTCP, RTP, TCP/IP, DHCP, PPPoE, Bonjour
Simultaneous Live View	Up to 20 channels
User/Host	Up to 32 users 3 levels: Administrator, Operator and User
Security Measures	User authentication (ID and PW), Host authentication (MAC address); HTTPS encryption; IEEE 802.1x port-based network access control; IP address filtering
<b>System Integration</b>	
Alarm Interface	7-ch alarm input/2-ch alarm output
Audio Interface	1-ch audio input (applicable microphone, plug-in power type), 2 to 2.4 V[p-p], 1 K $\Omega$ $\pm$ 10% 1-ch audio output, line level, impedance: 600 $\Omega$
Alarm Linkage	Alarm actions, such as Preset, Patrol Scan, Pattern Scan, Memory Card Video Record, Trigger Recording, Notify Surveillance Center, Upload to FTP/Memory Card/NAS, Send Email, etc.
Network Interface	1 RJ45 10 M/100 M Ethernet Interface; Hi-PoE
CVBS	Support
RS-485	HIKVISION, Pelco-P, Pelco-D, self-adaptive
Storage	Built-in memory card slot, support Micro SD/SDHC/SDXC, up to 256 GB; NAS (NPS, SMB/CIFS), ANR
API	Open-ended, support ONVIF, and CGI, support HIKVISION SDK and Third-Party Management Platform
Client	iVMS-4200, iVMS-4500, iVMS-5200, Hik-Connect
Web Browser	IE 8 to 11, Chrome 31.0 to 44, Firefox 30.0 to 51
<b>General</b>	
Power	24 VAC (Max. 60 W) Hi-PoE (Max. 50 W)
Working Temperature	Outdoor: -40°C to 70°C (-40°F to 158°F)
Working Humidity	$\leq$ 90%
Protection Level	IP67 Standard, IK10 (only supported by camera without wiper), TVS 6,000V Lightning Protection, Surge Protection and Voltage Transient Protection

Dimensions	Φ 266.6 mm × 410 mm (Φ 10.50" × 16.14")
Weight	Approx. 8 kg (17.64 lb)

**Order Model**





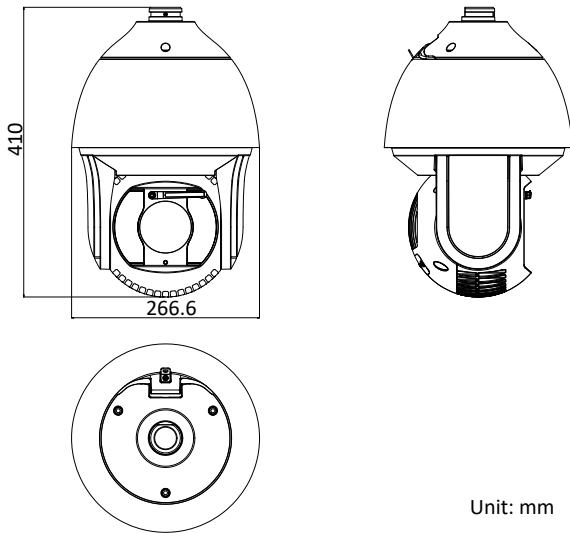



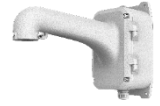

DS-2DF8836IX-AEL, without wiper, 24 VAC & Hi-PoE

DS-2DF8836IX-AELW, with wiper, 24 VAC & Hi-PoE

**Dimensions**

Unit: mm

## Accessories

	DS-1604ZJ	Wall Mounting Bracket
	DS-1604ZJ-box	Wall Mounting Bracket with Junction Box
	DS-1604ZJ-box-pole	Vertical Pole Mounting Bracket with Junction Box
	DS-1604ZJ-box-corner	Wall Mounting Bracket with Junction Box
	DS-1660ZJ	Parapet Wall Mounting Bracket
	DS-1619ZJ	Gooseneck Mounting Bracket
	DS-1661ZJ	Pendant Mounting Bracket
	DS-1662ZJ	Pendant Mounting Bracket
	DS-1663ZJ	Ceiling Mounting Bracket
	DS-1667ZJ	Extendable Pole for Pendant Mounting Bracket
	DS-1673ZJ	Horizontal Pole Mounting Bracket
	DS-1682ZJ	Extendable Pole for Pendant Mounting Bracket

**Headquarters**  
 No.555 Qianmo Road, Binjiang District,  
 Hangzhou 310051, China  
 T +86-571-8807-5998  
[overseasbusiness@hikvision.com](mailto:overseasbusiness@hikvision.com)

**Hikvision USA**  
 T +1-909-895-0400  
[sales.usa@hikvision.com](mailto:sales.usa@hikvision.com)

**Hikvision Italy**  
 T +39-0438-6902  
[info.it@hikvision.com](mailto:info.it@hikvision.com)

**Hikvision Singapore**  
 T +65-6684-4718  
[sg@hikvision.com](mailto:sg@hikvision.com)

**Hikvision South Africa**  
 Tel: +27 (10) 0351172  
[sale.africa@hikvision.com](mailto:sale.africa@hikvision.com)

**Hikvision Europe**  
 T +31-23-55-42-770  
[info.eu@hikvision.com](mailto:info.eu@hikvision.com)

**Hikvision France**  
 T +33(0)1-85-330-450  
[info.fr@hikvision.com](mailto:info.fr@hikvision.com)

**Hikvision Oceania**  
 T +61-2-8599-4233  
[salesau@hikvision.com](mailto:salesau@hikvision.com)

**Hikvision Hong Kong**  
 T +852-2151-1761

**Hikvision Middle East**  
 T +971-4-8816086  
[salesme@hikvision.com](mailto:salesme@hikvision.com)

**Hikvision Spain**  
 T +34-91-737-16-55  
[info.es@hikvision.com](mailto:info.es@hikvision.com)

**Hikvision Canada**  
 T +1-909-895-0400  
[sales.usa@hikvision.com](mailto:sales.usa@hikvision.com)

**Hikvision Russia**  
 T +7-495-669-67-99  
[saleru@hikvision.com](mailto:saleru@hikvision.com)

**Hikvision Poland**  
 T +48-22-460-01-50  
[poland@hikvision.com](mailto:poland@hikvision.com)

**Hikvision Korea**  
 T +82-31-731-8841  
[sales.korea@hikvision.com](mailto:sales.korea@hikvision.com)

**Hikvision India**  
 T +91-22-28469900  
[sales@pramahikvision.com](mailto:sales@pramahikvision.com)

**Hikvision UK**  
 T +01628-902140  
[support.uk@hikvision.com](mailto:support.uk@hikvision.com)

**Hikvision Brazil**  
 T +55 11 3318-0050  
[Latam.support@hikvision.com](mailto:Latam.support@hikvision.com)